



Installation Guide

Outdoor CPE



Setup with videos

Scan the QR code or visit

<https://www.tp-link.com/support/setup-video/>



Contents

Overview	01
Hardware Connection	04
Site Consideration	04
Connection and Installation	06
Lightning & ESD Protection	08
Software Configuration	10
Logging in to the PharOS	10
Typical Application Configuration	12
Antenna Alignment	14
Specifications	15
FAQ	16

Overview

TP-Link's Pharos series outdoor CPEs are dedicated to outdoor wireless network solutions. This guide is applicable to products including CPE205, CPE210, CPE220, and CPE510.

• Package Contents



Pharos CPE



Power Cord



Pole Mounting Straps

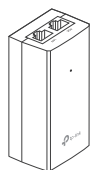

Passive PoE Adapter

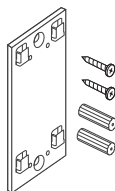

Mounting Bracket
Plastic Wall Anchors (Qty.2)
Self-tapping Screws (Qty.2)



Installation Guide

• LED Explanation

The following picture takes CPE220 as an example.



AP/AP Router Mode:

All four LEDs remain solid.

Client/Bridge/Repeater/AP Client Router Mode:

That the more LEDs lit will indicate better wireless signal strength.

On: A device is connected to this port, but there is no activity.

Flashing: A device is connected to this port, and is active.

On: The CPE is powered on.

• Panel Layout

Pharos CPE205/CPE220:

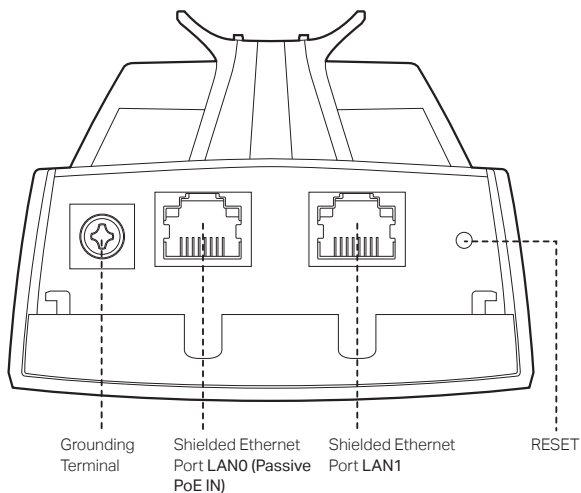

Pharos CPE210/CPE510:

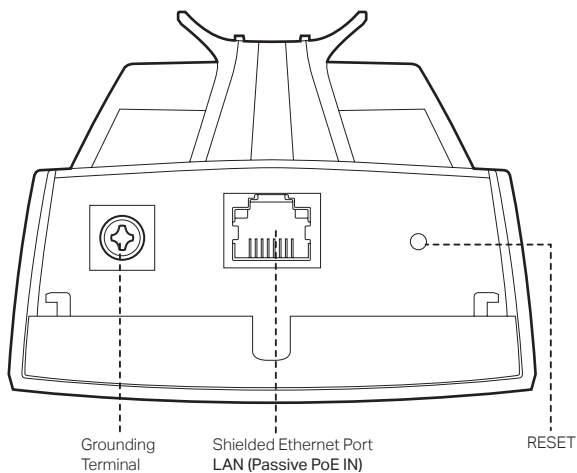

Passive PoE Adapter:

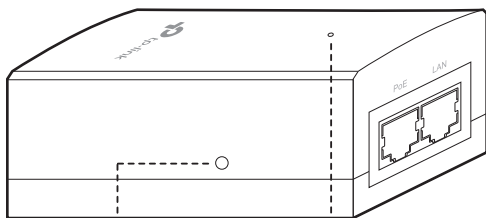

Remote Reset

Press and hold for about 8 seconds until CPE's LEDs of wireless signal strength and LAN flash.

Power LED

The Power LED is on when the passive PoE adapter is working normally.

Hardware Connection

1. Site Consideration

- **Mounting Height**

Ensure a clear line of sight between the wireless devices for an optimum performance. An elevated location is recommended as obstacles like trees, buildings and large steel structures will weaken the wireless signal.

See 'Q2' in 'FAQ' for details about how to calculate the minimum mounting height of the devices.

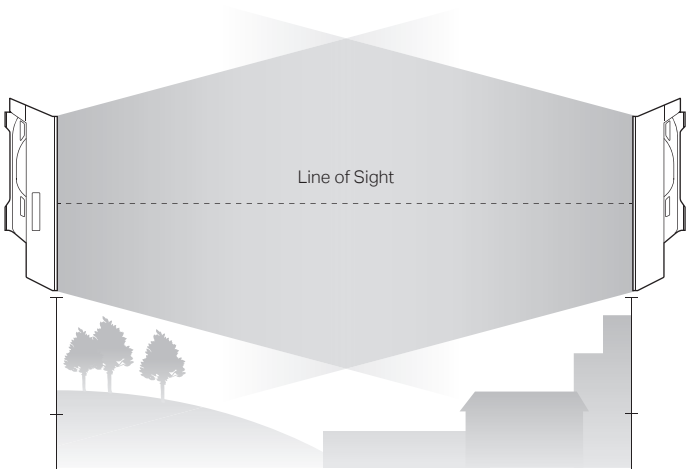

Side View

• Orientation

Install the CPE devices with the front facing the intended signal receiving devices. You can orient the devices with the assistance of Google Maps, GPS and some landmarks according to the horizontal beamwidth listed below.

Models	CPE210	CPE205/CPE220	CPE510
Horizontal Beamwidth	65°	60°	45°



2. Connection and Installation

Connect and mount the CPE and power adapter as shown below. The following introduction takes CPE220 as an example.

• Connecting CPE and Power Adapter

Connect the CPE and power adapter as shown in the figure below.

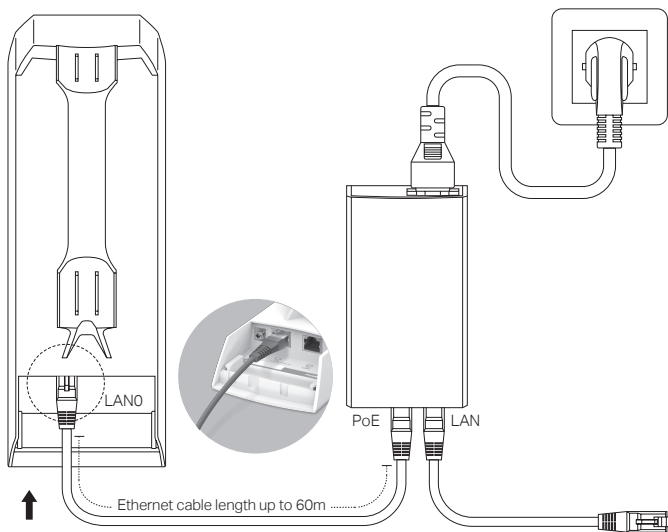

Ethernet cable length up to 60m

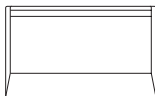

Slide to replace the cover of the CPE when all connections are finished.

You should prepare an adequate Ethernet cable to connect the CPE and the passive PoE adapter.

Shielded CAT5e (or above) cable with ground wire is recommended (refer to the next section).

Connect to a computer, router or switch. (Depending on your intended usage and/or network topology.)

• Mounting CPE

At the selected site, approximately align the CPE to the direction that you have oriented.

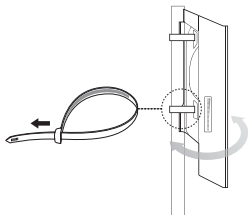

• Mounting Power Adapter (Optional)

Follow the steps below to mount the power adapter:

 To ensure the passive PoE adapter is attached most securely, it is recommended to install the adapter with the Ethernet port facing upward.

1. Drill two holes on the wall and insert the plastic wall anchors into the holes. Secure the mounting bracket to the wall. Make sure the shoulders at the corners of the mounting bracket are on the outside and pointing upward.

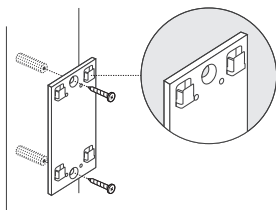

2. Attach the passive PoE adapter to the mounting bracket by sliding the adapter in the direction of the arrows until it locks into place.

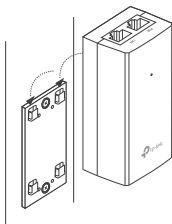

3. Lightning & ESD Protection

Proper grounding is extremely important for outdoor devices.

By using shielded CAT5e (or above) cable with ground wire for the connection and the provided PoE adapter (method ①), you can effectively eliminate ESD attacks. If you use the general CAT5e cable for the connection, then it is necessary to connect the grounding terminal of the CPE to earth ground through grounding cable (method ②).

The following introduction takes CPE220 as an example.

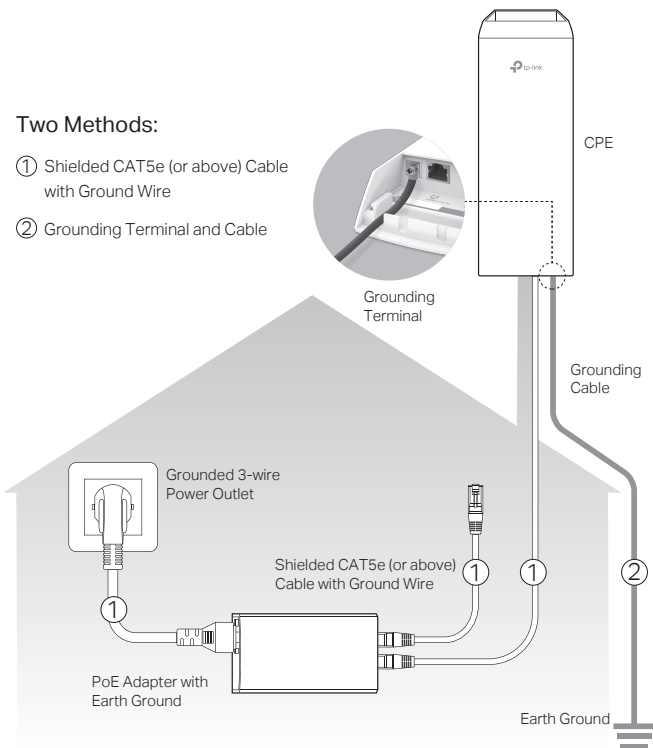

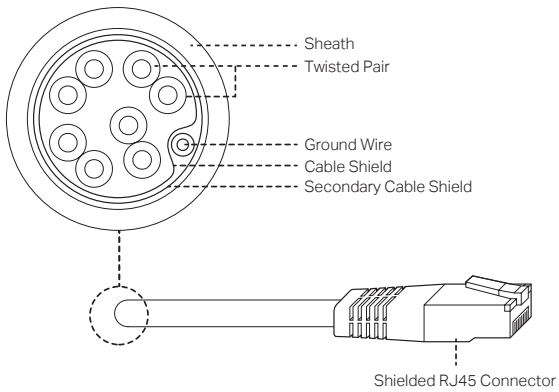

Shielded CAT5e (or above) Cable with Ground Wire

Software Configuration

This chapter introduces the login to the PharOS Web Interface and the software configurations.

1. Logging in to the PharOS

1. Before accessing the PharOS Web Interface, you need to assign a static IP address 192.168.0.X (X ranges between 2 and 253, e.g. 192.168.0.10) to your computer.

General

You can get IP settings assigned automatically if your network supports this capability. Otherwise, you need to ask your network administrator for the appropriate IP settings.

Obtain an IP address automatically

Use the following IP address:

IP address: 192 . 168 . 0 . 10

Subnet mask: 255 . 255 . 255 . 0

Default gateway:

Obtain DNS server address automatically

Use the following DNS server addresses:

Preferred DNS server:

Alternate DNS server:

Validate settings upon exit

Advanced...

OK Cancel

2. Open a web browser, type <http://192.168.0.254> into the address field and press **Enter** (Windows) or **return** (Mac). It is recommended to use the latest version of Google Chrome, Firefox or Safari.

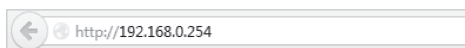

3. Enter **admin** for both **User Name** and **Password**. Read and agree the terms of use, then click **Login**.
4. Change the default User Name and Password to protect your CPE. Let's start configuring the CPE.



For subsequent logins, use the new username and password.

For more configurations, please visit <https://www.tp-link.com/support> to download the User Guide of Pharos products in the download center.

2. Typical Application Configuration

The typical topology is as follows. A wireless bridge is built between two locations that are far from each other. Follow the instructions below to configure the Access Point and Client.

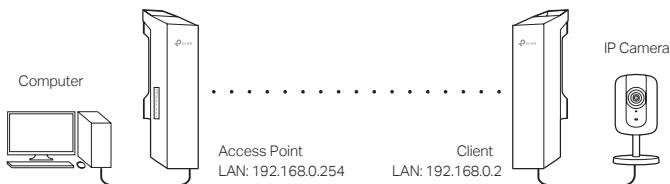

Configure the Access Point (AP)

1. Log in to PharOS and go to the Quick Setup page.
2. Operation Mode: Select **Access Point** and click **Next**.
3. LAN Settings: Click **Next**.
4. Wireless AP Settings:
 - a. Create a new SSID (Network name) for your wireless network.
 - b. Select **WPA-PSK/WPA2-PSK** for the Security method and create a PSK Password to protect your AP.
 - c. Enter the distance between the Access Point and the Client into the Distance Setting field.
 - d. Select the **MAXstream** checkbox (Refer to Q3 in FAQ for details about MAXstream), and click **Next**.
5. Finish: Verify your settings and click **Finish** to complete the configuration.

Configure the Client

1. Log in to PharOS and go to the Quick Setup page.
2. Operation Mode: Select **Client** and click **Next**.

3. LAN Settings: Change the IP Address to 192.168.0.X (X ranges between 2 and 253), the same subnet with the Access Point, and click **Next**.
4. Wireless Client Settings:
 - a. Click **Survey** and select the SSID of the Access Point in the AP list, then click **Connect**.
 - b. Select **WPA-PSK/WPA2-PSK** from the Security option, enter the same PSK password and distance value of the Access Point, then click **Next**.
5. Finish: Verify your settings and click **Finish** to complete the configuration.

For more configurations, please visit <https://www.tp-link.com/support> to download the User Guide of Pharos products in the download center.

Antenna Alignment

Antenna alignment can help you to optimize the antenna signal. To get the best wireless performance, click Antenna Alignment from the drop-down list on the upper-right corner and enable Alignment Beep during alignment. Then adjust your antenna until the sound frequency turns to the lowest.

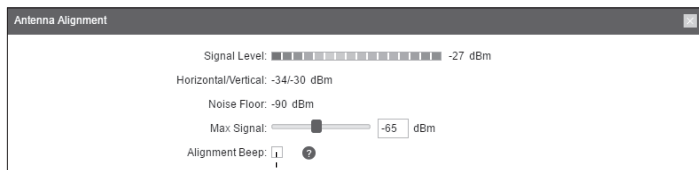

Check the box to enable the beep sound. Its frequency can help you to estimate the signal strength received by the antenna. The lower the sound frequency, the stronger the signal strength.



Specifications

HARDWARE FEATURES			
Models	CPE210/CPE510	CPE205/CPE220	
Dimensions	224 × 79 × 60 mm	276 × 79 × 60 mm	
Interface	LAN: 10/100 Mbps Ethernet Port (PoE IN)	LAN0: 10/100 Mbps Ethernet Port (PoE IN) LAN1: 10/100 Mbps Ethernet Port	
	GND: Grounding Terminal for Lightning Protection RESET: To restore the device to Factory Default		
Power Supply	Passive PoE Adapter Included CPE205/CPE210: 24 VDC/0.25 A CPE220/CPE510: 24 VDC/0.5 A		
ESD Protection ¹	15 kV		
Lightning Protection ¹	Up to 6 kV		
Operating Temperature	-40 °C to 70 °C (-40 °F to 158 °F)		
Operating Humidity	10% to 90%		
Certification	CPE210/CPE220/CPE510: CE, FCC, RoHS, IPX5 CPE205: RoHS, IPX5		
WIRELESS FEATURES			
Models	CPE210	CPE205/CPE220	CPE510
Antenna Gain	9 dBi	12 dBi	13 dBi
Horizontal Beamwidth/Elevation Beamwidth ²	65°/40°	60°/30°	45°/45°
802.11 Standards	11b/g/n	11b/g/n	11a/n

Note:

1. Estimation is based on copper grounding cable and shielded CAT5e cable with ground wire.
2. Beamwidth values may vary throughout operating frequency.

FAQ

Q1. How to restore the CPE to its factory default settings?

With the CPE powered on, you can reset the CPE via either the RESET button on the CPE or the Remote Reset button on the Passive PoE Adapter.

Method 1: Via the RESET Button on the CPE

The following picture takes CPE220 as an example.

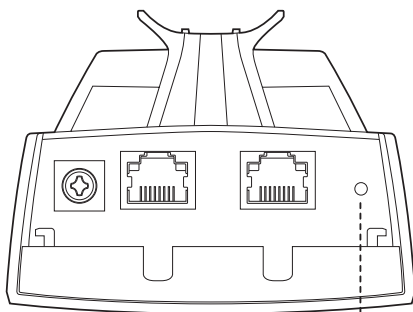

RESET Button

Press and hold for about 8 seconds until CPE's LEDs of wireless signal strength and LAN flash.

Method 2: Via the Remote Reset Button on the Passive PoE Adapter

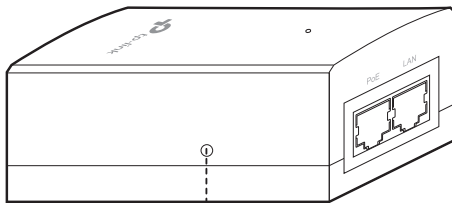

Remote Reset Button

Press and hold for about 8 seconds until CPE's LEDs of wireless signal strength and LAN flash.

Q2. How to calculate the minimum mounting height of the devices?

In order to maximize the received signal strength of the devices, installers need to minimize the effect of the out-of-phase signals, which is caused by obstacles in the path between the transmitter and the receiver. Fresnel Zone is a usual method to calculate this path, as shown in the formula and the figure below.

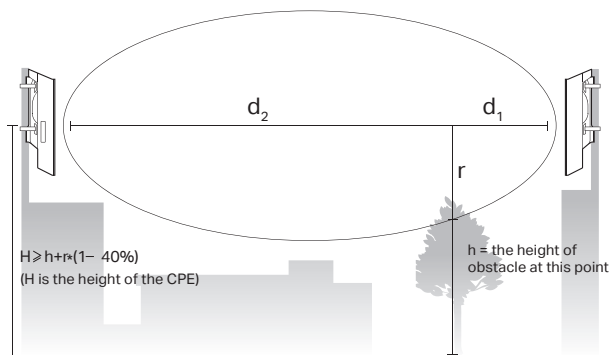

$$r = \sqrt{\frac{d_1 \times d_2}{d_1 + d_2} \cdot \frac{c}{f}}$$

where,

r = Fresnel zone radius in meters

$c = 3 \times 10^8$ m/s, speed of light

f = operating frequency of the devices in Hz

d_1 & d_2 = the distances between the point and the devices in meters

For example, assume d_1 is 2 km, d_2 is 8 km, and f is 2.4 GHz, then r would be 14.142 m. Considering a toleration of 40%, allowable radius would be 8.485 m. Assume h is 10 m, then the result of the minimum mounting height based on this point would be 18.485 m. Similarly, calculate the results based on all the points where there are obstacles, and the maximum value would be the final result.

For more information, please refer to:

https://en.wikipedia.org/wiki/Fresnel_zone

Q3. What is Pharos MAXstream?

Pharos MAXstream is a proprietary protocol developed on the basis of Time Division Multiple Access (TDMA) by TP-Link.

The MAXstream technology has the following advantages:

- Eliminates hidden node collisions and improves channel efficiency.
- Lower latency, higher throughput, larger network capacity and more stability.
- Improves the QoS for video, voice and sound data stream.

By dividing the timing of transmission into different time slots, MAXstream allows the Pharos devices to transmit in rapid succession, one after another, each using its own time slot to transmit and receive their own frames, which greatly reduces the chance of collision.

Pharos MAXstream is a non-standard Wi-Fi protocol that is only compatible with TP-Link's Pharos series products. Please notice that you will not be able to connect other Wi-Fi devices to an AP with MAXstream enabled.

Q4. How can I use Spectrum Analysis to find the appropriate channel for the devices?

1. Log in to PharOS, click **Spectrum Analysis** in the tools drop-down list, a window will pop up to remind you that all wireless connections will be lost during spectrum analysis. Click **Yes** to continue to the Spectrum Analysis page.

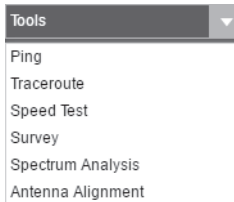

2. Click **Start**, the Pharos will begin to analyze the power of frequency. Observe the curves for a period of time, and then click **Stop**. Note that the relatively low and continuous part of the average curve

indicates less radio noise. Here, we use the figure below as an example.

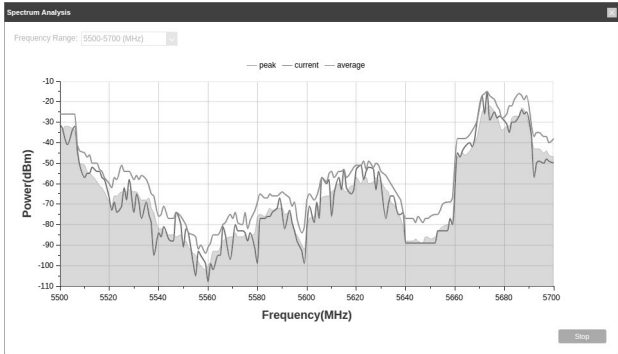

⚠ The select box of Frequency Range at the top-left corner is only available for CPE510. Select the desired range and then click Start.

When choosing channel/frequency, you should avoid the spectrum with large radio noise. In this example, the recommended channel/frequency is 112/5560 MHz.

Note: To ask questions, find answers, and communicate with TP-Link users or engineers, please visit <https://community.tp-link.com> to join TP-Link Community.

Safety Information

- Keep the device away from fire or hot environments. DO NOT immerse in water or any other liquid.
- Do not attempt to disassemble, repair, or modify the device. If you need service, please contact us.
- Do not use damaged charger or USB cable to charge the device.
- Do not use any other chargers than those recommended
- Do not use the device where wireless devices are not allowed.
- Adapter shall be installed near the equipment and shall be easily accessible.



Use only power supplies which are provided by manufacturer and in the original packing of this product. If you have any questions, please don't hesitate to contact us.

Please read and follow the above safety information when operating the device. We cannot guarantee that no accidents or damage will occur due to improper use of the device. Please use this product with care and operate at your own risk.



Продукт сертифіковано згідно с правилами системи УкрСЕПРО на відповідність вимогам нормативних документів та вимогам, що передбачені чинними законодавчими актами України.

EAC



To ask questions, find answers, and communicate with TP-Link users or engineers, please visit <https://community.tp-link.com> to join TP-Link Community.



For technical support, the user guide and other information, please visit <https://www.tp-link.com/support>, or simply scan the QR code.



If you have any suggestions or needs on the product guides, welcome to email techwriter@tp-link.com.cn.



The products of TP-Link partly contain software code developed by third parties, including software code subject to the GNU General Public License ("GPL"). As applicable, the terms of the GPL and any information on obtaining access to the respective GPL Code used in TP-Link products are available to you in GPL-Code-Centre under (<https://www.tp-link.com/en/support/gpl/>). The respective programs are distributed WITHOUT ANY WARRANTY and are subject to the copyrights of one or more authors. For details, see the GPL Code and other terms of the GPL.